

Electrical amplifiers

RE 29904/09.04
Replaces: 05.02

1/8

Type VT 2000

Component series 5X

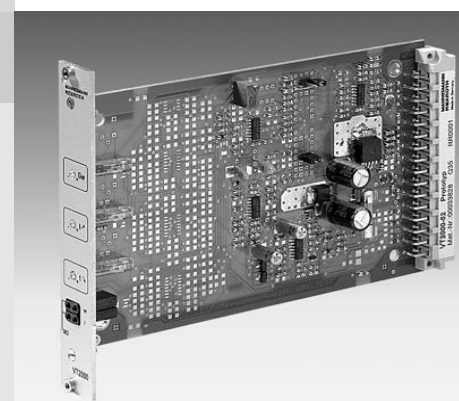

H/A/D 5896/97

Table of contents

Features	1
Ordering code	1
Functional description	2
Troubleshooting	2
Block circuit diagram / pin assignment	3
Technical data	4
Output characteristic curve	5
Indicator / adjustment elements	5
Unit dimensions	6
Engineering / maintenance notes / supplementary information	6

Features

- Suitable for controlling direct and pilot operated proportional pressure control valves without electrical position feedback
- Differential input
- Additional command value input, 0 to +9 V
- Ramp generator, separately adjustable for up and down ramps
- Clocked current output stage
- Reverse polarity protection for voltage supply
- Short-circuit protection of solenoid cable

Card holder:

- Type VT 3002-2X/32, see RE 29928
- Single card holder without power supply unit

Power supply unit:

- Type VT-NE30-1X, see RE 29929
- Compact power supply unit 115/230 VAC → 24 VDC, 70 VA

Ordering code

VT 2000 - 5X / *

Amplifier for proportional pressure control valves without electrical position feedback

Component series 50 to 59
(50 to 59: unchanged technical data and pin assignment)

= 5X

Further details in clear text

When ordering spares for amplifier type VT 2000 up to series 4X, a 4TE/3HE blind plate must be ordered separately.

Material no. R900021004

Functional description

The command value voltage can be applied to command value input 1 either directly or via an external command value potentiometer using the regulated + 9 V voltage from the power supply unit [8].

The following is valid for this input: + 9 V = + 100 % ¹⁾.

External command value feedforward

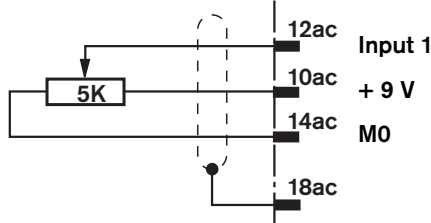

Note:

If an external command value potentiometer is used, the internal potentiometer "Gw" [3] must be set to maximum or the desired maximum pressure.

Internal command value feedforward

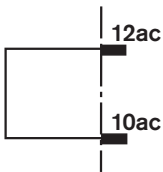

Differential input (input 2)

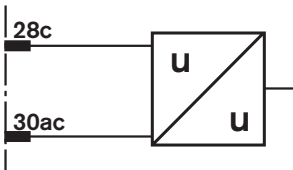

Command value input 2 is a differential input [1] (0 to + 10 V). If the command value is fed forward by external electronics with another reference potential (e.g. from a PLC), this input must be used. When cutting the command value voltage in or out, take care that both signal cables are connected to or disconnected from the input.

Before being passed on, both command values are summated [2] and fed to a potentiometer [3] that is accessible at the front panel of the card and acts as attenuator for limiting the maximum command value.

The downstream ramp generator [4] generates a ramp-shaped output signal from a stepped input signal. The time constant of this signal can be adjusted separately for up and down ramps by means of two potentiometers. The specified ramp time refers to a command value step-change of 100% and can be approx. 1 s or 5 s, depending on the jumper setting. If a command value step-change of less than 100 % is applied to the input of the ramp generator or when the attenuator [3] is active, the ramp time shortens accordingly.

With the help of the external contacts "ramp up/down" the up and down ramp times can be set separately to their minimum value (approx. 30 ms).

Ramp "up/down" OFF

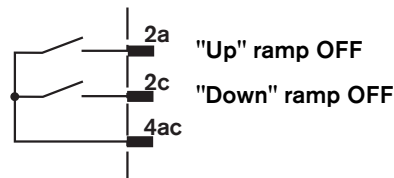

The output signal of the ramp generator [4] is the internal current command value and is fed to measuring socket "w" at the front panel of the card. Here, a command value of 100 % corresponds to a voltage of + 6 V. In addition, the command value is passed on via the current regulator [5] to the current output stage [6]. The current regulator [5] adds the value of potentiometer "Zw" (R130) for the biasing current to the value from the ramp generator. The current command value is modulated with the clock pulse encoder signal [7]. The clocked actual current value acts like a constant current with superimposed dither signal in the solenoid of the valve. The actual current value through the solenoid can be measured at socket "I". Here, a voltage of 800 mV corresponds to a current of 800 mA.

¹⁾ Reference potential for command value 1 is M0 (measurement zero).

[] ... Cross-reference to block circuit diagram on page 3

Troubleshooting

If the VT 2000 amplifier card is not operable, follow the steps below for troubleshooting:

1. Is the operating voltage applied?
Measure contacts 24ac against 18ac
2. Is the fuse on the card defective?
3. Is the internal operating voltage of ± 9 V available on the card?
4. If the internal command value potentiometer is used, is the jumper from 10ac to 12ac plugged?
5. Is the external potentiometer correctly connected?
(for the connection, see top left)

6. Is the differential input properly connected?

Check: Reference potential at 30ac
0 to + 10 V at 28c

7. Is the solenoid properly connected?

When the card is unplugged, a resistance of approx. 20 to 30 Ω must be measurable between contacts 22ac and 20ac.

8. The internal command value potentiometer "Gw" must not be turned to the left-hand limit stop ("zero").

Note:

In the case of excessive temperatures (e.g. caused by overloading), the output stage shuts down. This fault is not signalled separately!

Block circuit diagram / pin assignment

Measurement zero (MO) is raised by 9 V as against 0V operating voltage.

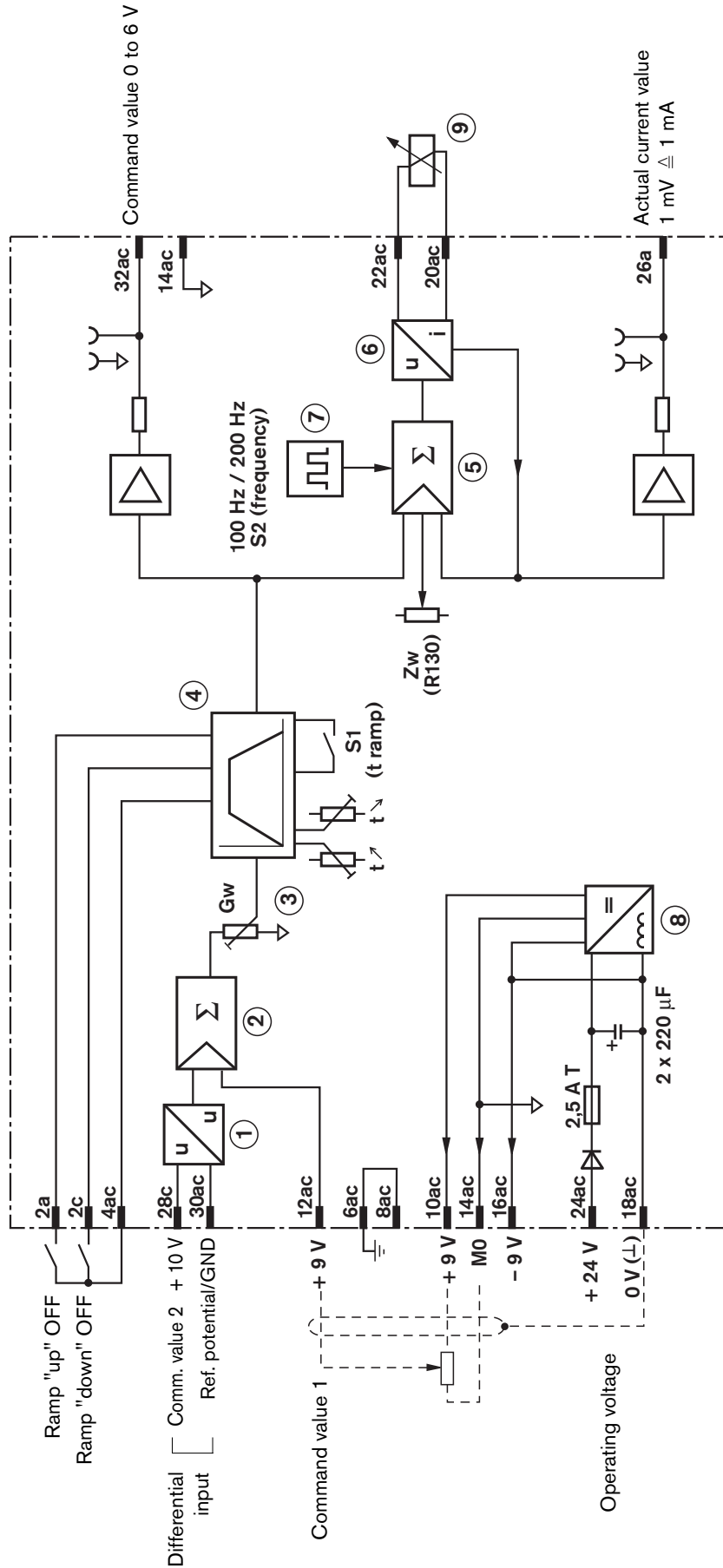

- 1 Differential input
 - 2 Summator
 - 3 Max. command value attenuator
 - 4 Ramp generator
 - 5 Current regulator with summator
 - 6 Current output stage
 - 7 Clock-pulse generator
 - 8 Power supply unit
 - 9 Proportional solenoid of the valve
- Gw = Command value attenuation
 - t = Ramp time adjustment
 - Zw (R130) = Additional biasing current setting (0 to 300 mA)

Technical data (for applications outside these parameters, please consult us!)

Operating voltage	U_O	24 VDC + 40 % – 5 %
Operating range:		
– Upper limit value	$u_O(t)_{\max}$	35 V
– Lower limit value	$u_O(t)_{\min}$	22 V
Power consumption	P_S	< 25 VA
Current consumption	I	< 1 A
Fuse	I_F	2.5 A T
Inputs:		
– Command value 1	U_i	0 to + 9 V (reference potential is M0)
– Command value 2 (differential input)	U_i	0 to + 10 V; $R_i = 100 \text{ k}\Omega$
Ramp time (adjustment range)	t	30 ms to approx. 1 s or 5 s (depending on setting of S1)
Outputs:		
– Output stage		
• Solenoid current / resistance	I_{\max}	800 mA ¹⁾ + 10 % – 5 %; $R_{(20)} = 19.5 \Omega$
• Biasing current	I_V	0 mA to 300 mA; adjustable using potentiometer "Zw (R130)" on the printed circuit board
• Clock frequency	f	100 Hz or 200 Hz; $\pm 10 \%$ each; depending on the setting with jumper S2 ("frequency")
– Regulated voltage	U	$\pm 9 \text{ V} \pm 1 \%$; $\pm 25 \text{ mA}$, externally loadable
– Measuring sockets		
• Command value "w"	U	0 to + 6 V (+ 6 V \triangleq 100 %); $R_i = 1 \text{ k}\Omega$
• Actual current value "I"	U	0 to 800 mV \triangleq 0 to 800 mA $\pm 10 \text{ mA}$
Type of connection		32-pin male connector, DIN 41 612, form D
Card dimensions		Euro-card 100 x 160 mm, DIN 41 494
Front panel dimensions:		
– Height		3 HE (128.4 mm)
– Width soldering side		1 TE (5.08 mm)
– Width component side		3 TE
Permissible operating temperature range	ϑ	0 to 50 °C
Storage temperature range	ϑ	– 25 to + 85 °C
Weight	m	0.1 kg

¹⁾ The maximum current I_{\max} can be adjusted to the required value using the command value attenuator (potentiometer "Gw" on the front panel).

Note:

For details regarding **environment simulation testing** in the fields of EMC (electromagnetic compatibility), climate and mechanical stress, see RE 30111-U (declaration on environmental compatibility).

Output characteristic curve

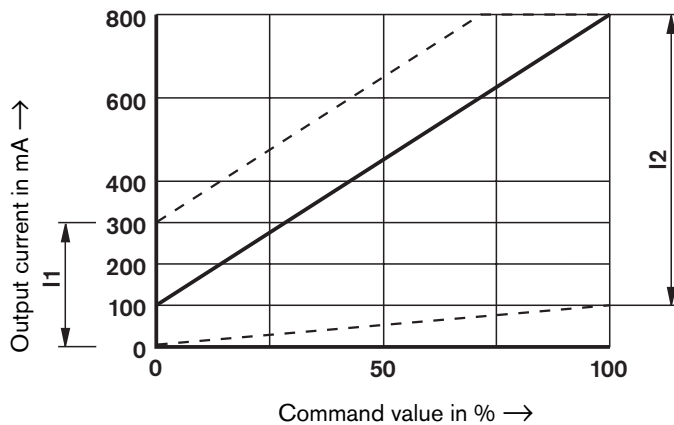

- I1** Adjustment range of the biasing current (0 to approx. 300 mA) with potentiometer "Zw (R130)" on the printed circuit board
- I2** Adjustment range of the maximum command value with potentiometer "Gw" on the front panel
- A** Output characteristic curve with factory setting

Indicator / adjustment elements

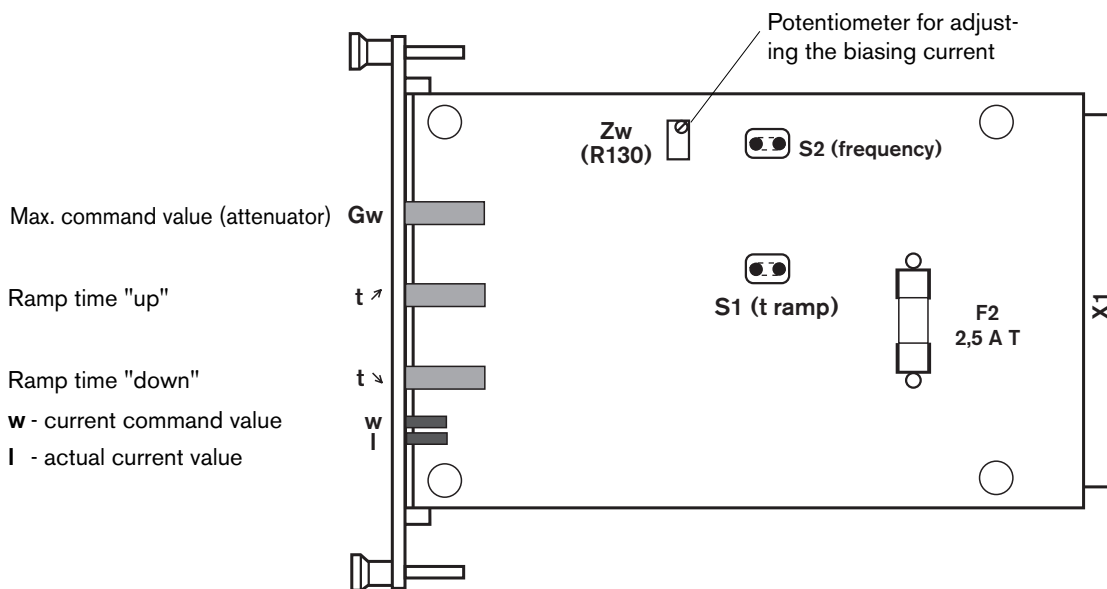

Meaning of the jumpers on the card for the settings

(nameplate on the printed circuit board)

<p>ramp time</p> <p>○ • 5 s S1</p> <p>○ 1 s S1</p>	<p>frequency</p> <p>○ 100 Hz S2</p> <p>○ • 200 Hz S2</p>	<p>Sx = bridge</p> <p>Sx = open</p> <p>• = delivery state</p>	<p> Jumper plugged</p> <p>or</p> <p> Jumper open</p>
---	---	---	--

Note:

The circles (○) serve for marking the settings made by the customer.

The factory setting is identified with "•".

Unit dimensions (dimensions in mm)

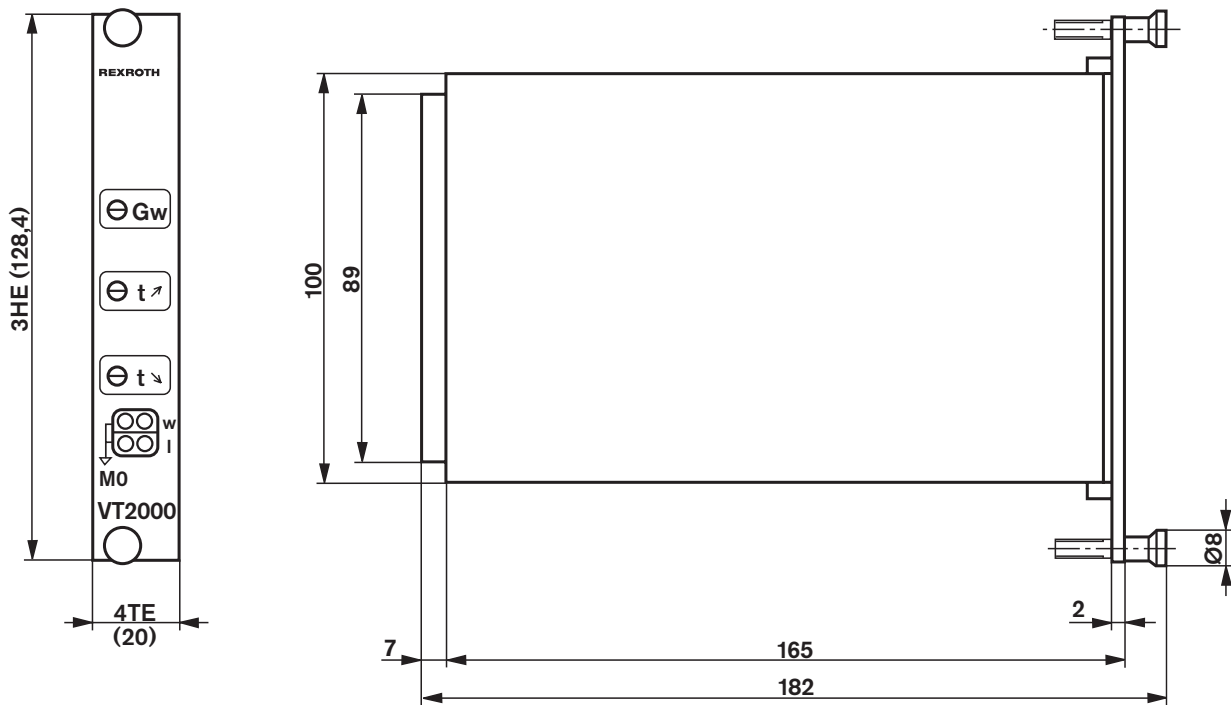

Engineering / maintenance notes / supplementary information

- Before commissioning the amplifier, make sure that the jumpers on the printed circuit board are plugged according to the relevant application.
- With the factory setting, an amplifier of series 5X is interchangeable with series 4X with a ramp time of 5 s and a clock frequency of 200 Hz.
If a series 5X amplifier is to be used as substitute for a device of series 4X, a blind plate having a width of 4TE must be ordered separately (see ordering code on page 1).
- The amplifier may only be installed when disconnected from the power supply!
- Do not use plug-in connectors with free-wheeling diodes or LED lamps for connecting the solenoids!
- Measurements on the card may only be taken using instruments with $R_i > 100 \text{ k}\Omega$!
- The measurement zero (M0) is raised by + 9 V as against the 0V operating voltage and is not electrically isolated, i.e. - 9 V regulated voltage \triangleq 0V operating voltage.
The measurement zero (M0) must therefore not be connected to the 0V operating voltage!
- Use relays with gold-plated contacts for passing on command values (small voltages, small currents)!
- Always shield command value cables; connect the shield to ground on the card side and leave the other end open. The card must be connected to ground at connection 6 or 8. If no system ground is available, connect 0V operating voltage.
Recommendation: Also shield solenoid cables!
For solenoid cable lengths up to 50 m, use cable type LiYCY 1.5 mm².
For greater lengths, please consult us!
- The distance to aerial lines, radio sources and radar equipment must be at least 1 m!
- Do not lay solenoid and signal cables near power cables!
- Because of the charging current of the smoothing capacitors on the card, back-up fuses must be of the slow-blowing type!
- **Caution:** When using the differential input, both inputs must always be activated or deactivated simultaneously!
- **Note:** Electrical signals (e.g. actual value) brought out via control electronics must not be used for switching safety-relevant machine functions!
(See also European standard "Safety requirements for fluid power systems and components – hydraulics", prEN 982)

Notes

Notes
